



InDomo[®] and StairFit[®]

Homelifts



MADE IN ITALY





Why a home lift?

Our home lifts are designed to solve the needs of vertical mobility and to remove architectural barriers in all environments, both private and public.

They represent the ideal solution to overcome the stairs and rediscover the pleasure of moving freely in every moment of the day.

They can be installed both inside and outside the building in special metal structures or between the walls of the house.

They ensure a high level of ride comfort, great reliability and total safety, for example guaranteed by the automatic emergency lowering system in the event of a power failure.

They can be installed in new buildings but fit perfectly every existing environments, increasing their value.



Safety

Thanks to the wide range of specific devices you can move every day around the house without worries.

Comfort

It can be operated by pressing the button, both in the cabin and on the landings. Choosing the version with automatic sliding or folding doors in the car, you will not have to hold the button pressed during the entire travel.

Style

Decorate the space in motion by choosing the finishes that best suit your environments and satisfy your taste as you would do for any furnishing accessory. Our renewed range of cabins, Smart - Idea - Style and Opera, best represents the expression of MADE IN ITALY.

Reduced spaces

StairFit is our compact model created to be installed in limited spaces and ideal for staircases with particularly reduced width. Each lift is made to measure in order to take advantage of every single centimetre available.

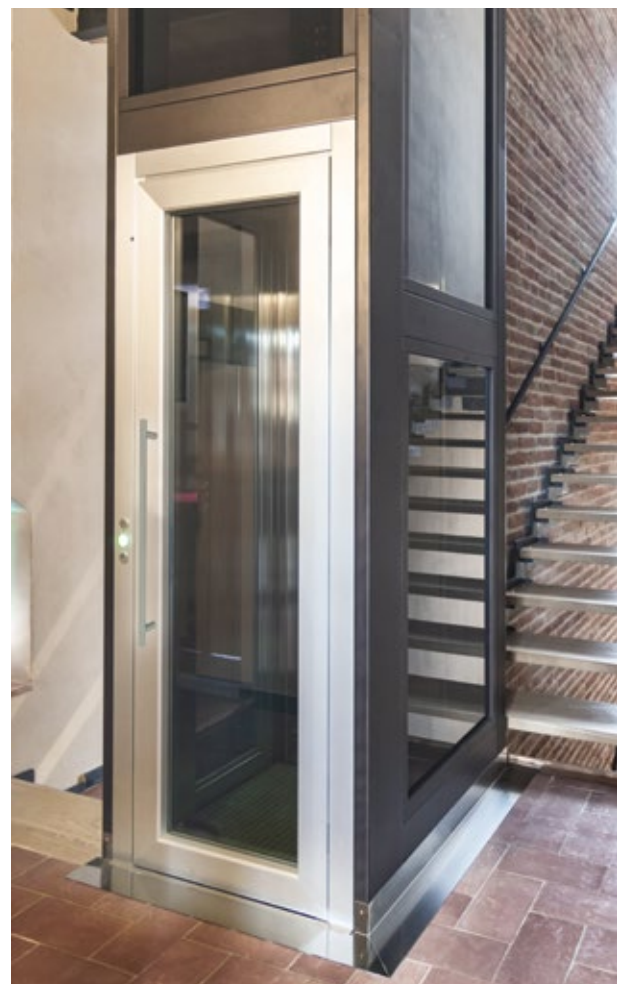

Indoor and outdoor homelifts

InDomo can be installed both inside and outside the building to ensure maximum accessibility at all levels. StairFit is thought to be positioned in an indoor stairwell.

If you do not have specific shaft you can connect the lift directly to the balcony or using existing windows modified to obtain the necessary entrances.

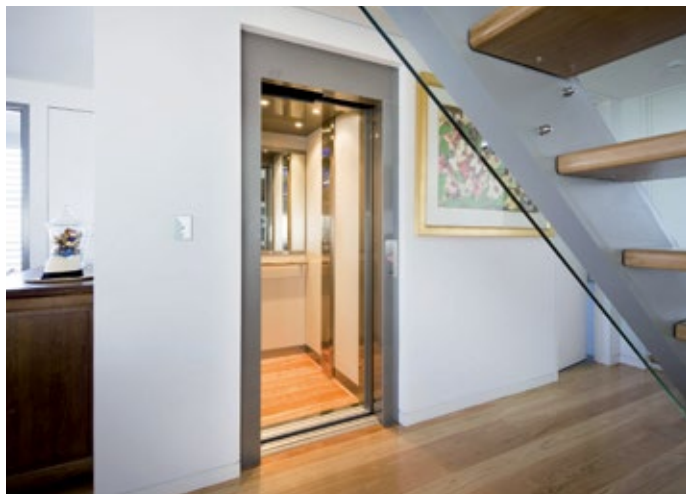

Small elevators for private homes and public environments

Our products find their natural connotation mainly in private homes to help you live fully your environments.

Nevertheless, they are the ideal solution to overcome architectural barriers in public environments like schools, shops, restaurants, offices and can guarantee the right solution to all needs.



Masonry shaft or metallic structure

The lift travels inside a shaft to guarantee the maximum safety, according to the law. The shaft can be obtained inside the house making it in masonry or concrete.

Alternatively we can provide a metal structure designed for indoor or outdoor (since it is weather-proof), certified according to the anti-seismic rules. The structure has multiple finishes and can be completely glazed to ensure good aesthetic result, lightness and visibility.



Swing doors or automatic doors

As standard, InDomo and StairFit lifting platforms are offered with swing glazed doors that guarantee maximum visibility and passive safety.

They can also be equipped with automatic sliding doors or with internal folding doors and external automatic swing doors (myDOMO) which allow automatic control avoiding to keep the button pressed during the entire travel.





Cabin

SMART

Beauty
and simplicity

With its up-to-date, minimalist and yet affordable design, this is LiftingItalia best-selling cabin, now available with new eye-catching skinplate texture finishes.

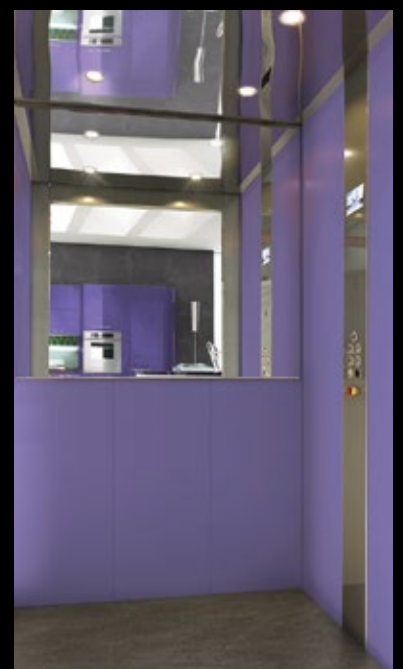

InDomo homelift cabin

Full height COP
in scotch brite ST/ST



Cabin

IDEA

Elegance
and flexibility

Bright, fresh and available in a wide colour range, this cabin boasts a plain and youthful design that brings sparkle to its surroundings.

IDEA is the cabin designed specifically for panoramic lifts and offers the possibility of having up to three glass walls.

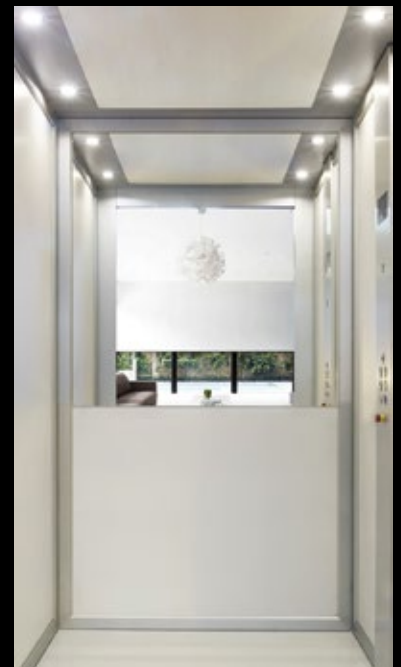

InDomo and **StairFit** homelift cabin

Full height COP in
anodized aluminum

Internal car profiles
in anodized aluminum

External wall cladding
in anodized aluminum



Cabin

STYLE

Timeless style

The material combinations are designed to exalt the enduring look of the stainless steel, which enhance both classic and modern environments.

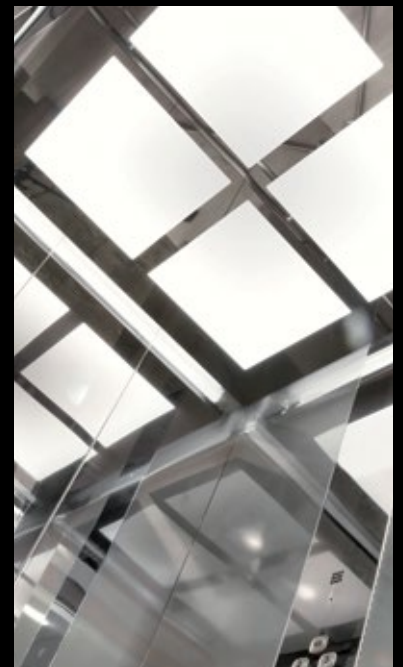

InDomo homelift cabin

Full height COP in polished
Mirror ST/ST



Cabin

OPERA

Warmth and
accessible luxury

We chose a selection of the most interesting contemporary design materials, to create a uniquely refined cabin design.



InDomo homelift cabin

3/4 height COP
in anodized aluminum

Internal car profiles
in anodized aluminum

External wall cladding
in anodized aluminum



Doors

LUMIERE DOOR

Single panel swing door

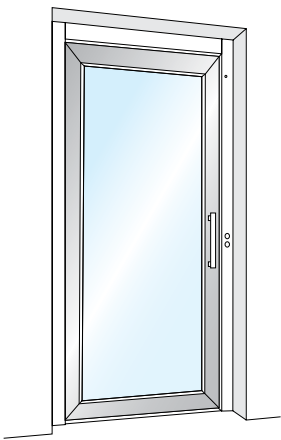

Aluminum Handle
Height 700 mm
Cod. ML.05 (Standard)

Single panel swing door; manual opening and automatic closing.

Available versions:

- FBL (blind)
- GL (glazed)
- Landing door finishes: **Silver anodized aluminium (standard) and Painted steel**



Stainless Steel Handle
Height 200 mm
Cod. ML.02 (Optional)



Stainless Steel Handle
Height 700 mm
Cod. ML.06 (Optional)

AUTOMATIC DOORS KIT MYDOMO-PACK

Double panels swing automatic landing door

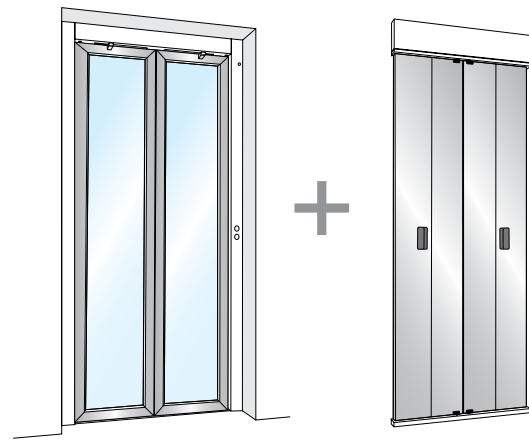

Double panels swing landing door coupled with a folding car door completely automatic in opening and closing operations. A safety device stops the movement in case of obstruction.

MyDOMO landing door and TWIST folding car door are also available:

- GL (glazed)
- BL (blind)
- Car door finishes: **Scotch Brite Stainless Steel (standard) and Painted steel**
- Landing door finishes: **Silver anodized aluminium (standard) and Painted steel**



2 PANELS AUTOMATIC

Centre opening door

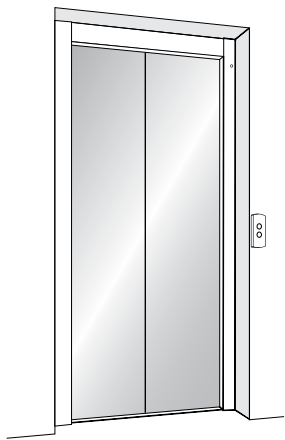

Car and landing 2 panels automatic centre opening door with safety device to re-open in case of obstructions.

Versions: BL (blind - std) - GL (glazed)

Available also:

- Fire rated E120
- Fire proof EI120

- Standard finishes: **F12PPS**
Stainless-Look Skinplate
- Optional finishes: **Stainless Steel**
and **Painted steel**

2 PANELS AUTOMATIC

Side opening door

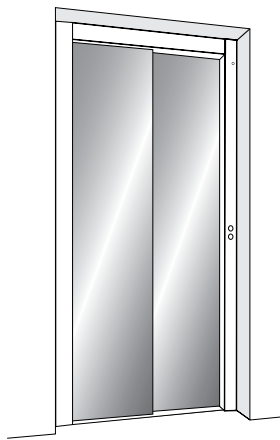

Car and landing 2 panels automatic side opening door with safety device to re-open in case of obstructions.

Versions: BL (blind - std) - GL (glazed)

Available also:

- Fire rated E120
- Fire proof EI120

- Standard finishes: **Skinplate**
- Optional finishes: **Stainless Steel**
and **Painted steel**

3 PANELS AUTOMATIC

Side opening door

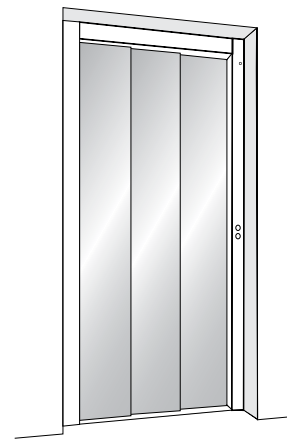

Car and landing 3 panels automatic side opening door with safety device to re-open in case of obstructions.

Versions: BL (blind - std) - GL (glazed)

Extremely thin:

- 60 mm sill
- 180 mm horizontal transom

- Standard finishes: **Skinplate**
- Optional finishes: **Stainless Steel**
and **Painted steel**

COP

COP STANDARD CONFIGURATION

- ☞ Braille push buttons
- ☞ Alarm button
- ☞ Luminous and acoustic overload signal
- ☞ Door open push button (only with automatic doors)
- ☞ Emergency STOP button (only without car doors)
- ☞ Emergency light
- ☞ Two-way intercom
- ☞ **StairFit** is equipped with a horizontal COP on the rear wall

PUSH BUTTONS

- ☞ The push button (∅ 29,6 mm) features Braille code
- ☞ Blue backlight
- ☞ Dimensions with bezel 42 x 38 mm
- ☞ Matt stainless steel/gold finish



OPTIONS

- ☞ Enabling key
- ☞ Magnetic iButton key
- ☞ Position and direction displays
- ☞ Phone dialler
- ☞ Wall phone
- ☞ In-built telephone box (where possible)
- ☞ LCD Display (5,6")
- ☞ TFT Display (7")



Embossed COP,
anodized aluminum,
3/4 height or full height

Width 220 mm
Depth 25 mm



Flush COP,
full height,
scotch brite or mirror
finish stainless steel

Width 220 mm



Display

CAR DISPLAY - OPTIONAL



TFT (7")
Without frame
Dimensions:
154 x 86 mm



Tricolor LCD (5,6")
With metal frame
Dimensions:
120 x 60 mm

LANDING DISPLAY - OPTIONAL



On the
door frame



On the wall

Ceilings

PLEXY CEILING

not backlighted (standard)



- Standard ceiling for **SMART - IDEA - OPERA** cars
- Standard finishes: **Scotch Brite Stainless Steel** and **Anodized aluminium**
- Optional finishes: **Mirror Stainless Steel**

COUNTER-CEILING QUADRO

backlighted



- Standard counter-ceiling for **STYLE** car
- Optional counter-ceiling for **SMART - IDEA - OPERA** cars
- Standard finishes: **Scotch Brite** or **Mirror Stainless Steel**

COUNTER-CEILING WINDOW

backlighted



- Standard counter-ceiling for **STYLE** car
- Optional counter-ceiling for **SMART - IDEA - OPERA** cars
- Standard finishes: **Scotch Brite** or **Mirror Stainless Steel**

COUNTER-CEILING SPOTLIGHTS

with LED spot lights



- Standard counter-ceiling for **STYLE** car
- Optional counter-ceiling for **SMART - IDEA - OPERA** cars
- Standard finishes: **Scotch Brite** or **Mirror Stainless Steel**

Handrail

Modular aluminum handrails with the following finishes:

- natural anodized aluminum
Cod. CR.03
- aluminum stainless steel effect
Cod. CR.04

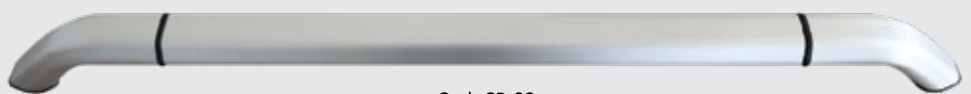

Cod. CR.03



Cod. CR.04

Finishes - Skinplate

For **AUTOMATIC DOORS** and **IDEA** and **SMART** cars



DT 63
Rough Fabric



DT 64
Kaki Fabric



DT 65
Grey Fabric



A80SMA
White Ice



B17SMA
Soft Violet



F12PPS
Stainless-Look



PPS10
Marble



F21PVA
Dotted Silver

Finishes - Laminate HPL

For **IDEA** and **OPERA** cars

ROUGH FINISH



410
White Ice



868
Medium Grey

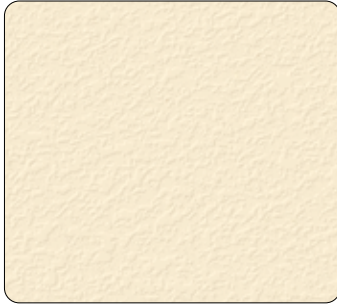

810
White Mini

Finishes - Laminate HPL

MATT FINISH

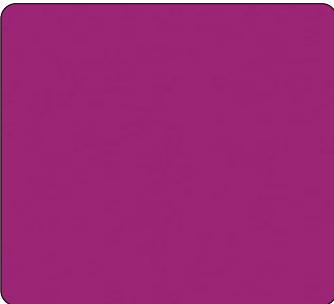

1821
Holy Violet

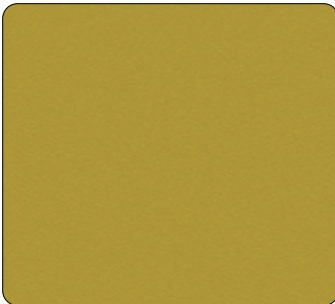

1855
Pistachio Green

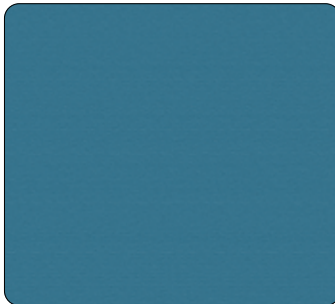

856
Blue Steel

GLOSSY FINISH



836
Plum Red



1883
Aubergine

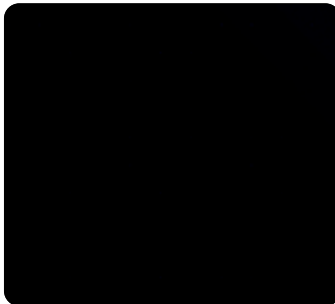

421
Black

WOOD EFFECT WITH HORIZONTAL TEXTURE



1619
Light Transversal Oak



1381
Transversal Oak



1382
Transversal Tobacco

WOOD EFFECT WITH VERTICAL TEXTURE



1385
White Ash

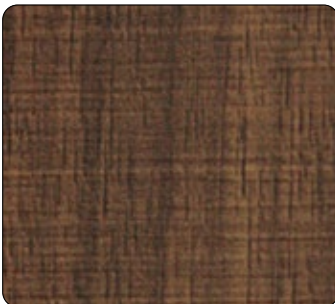

1389
Noce Iseo

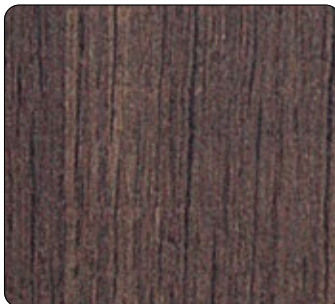

1387
Smoked Wood

Finishes - Stainless Steel

For **CAR WALLS** and **AUTOMATIC DOORS**



Satin Gr. 240
Stainless Steel

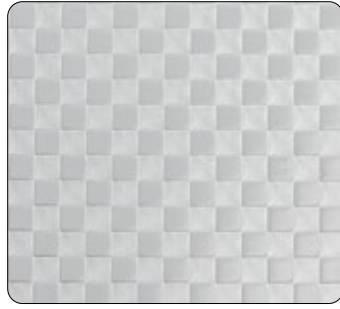

D21 Square
Stainless Steel



D25 Linen
Stainless Steel

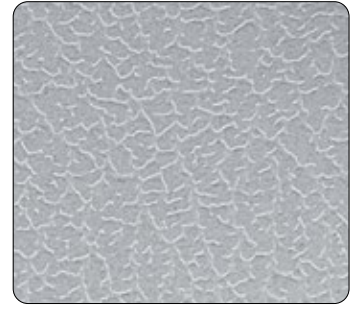

D42 Leather
Stainless Steel

For **LUMIERE DOORS**



Scotch Brite
Stainless Steel



Mirror
Stainless Steel

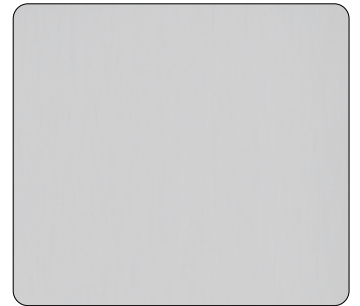

Anodized aluminium

Finishes - Glasses and mirrors



Natural

Acid
Etched

Natural
Milky White

Milky White
Extraclear

Smoke Grey

Bronze Stopsol

Mirror

Finishes - Floors

GRANITE AGGLOMERATE



GRANIT RS607
White

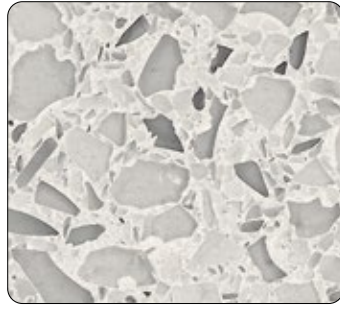

GRANIT TC2400
White Mix

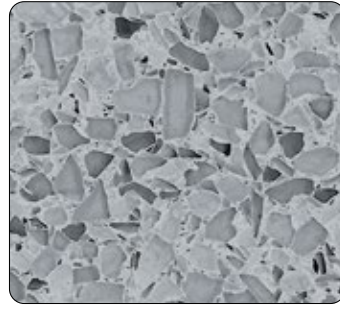

GRANIT TC2402
Grey

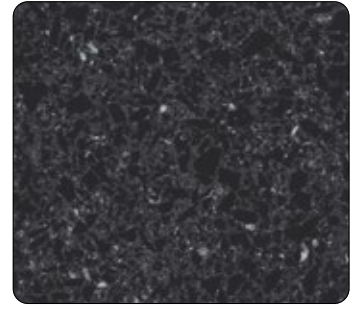

GRANIT RS646
Black

WOODEN PLANKS



PARQUET LW1
Whitened oak



PARQUET LW2
Doussie

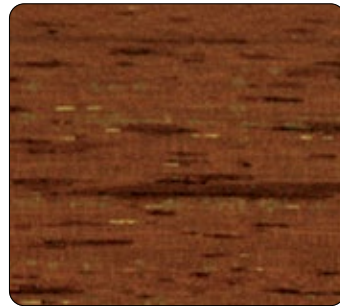

PARQUET LW3
Merbau



PARQUET LW4
Teak

PVC "ETERNAL COLLECTION"

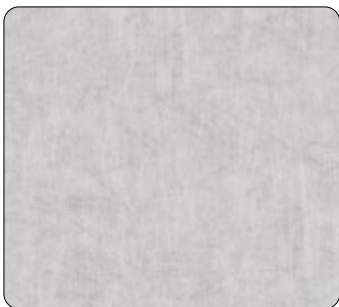

13772
Eternal Brushed Aluminium

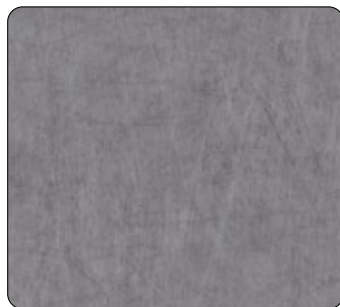

13712
Eternal Brushed Chrome

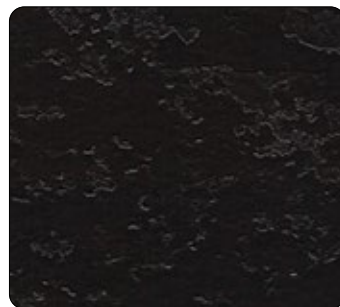

42292
Eternal Charcoal Slate

ROUND STUDDED RUBBER

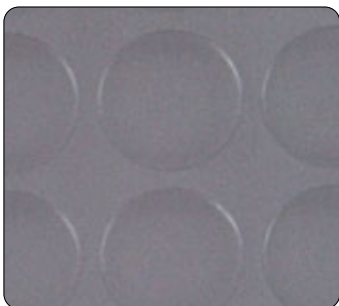

G804
Light Grey

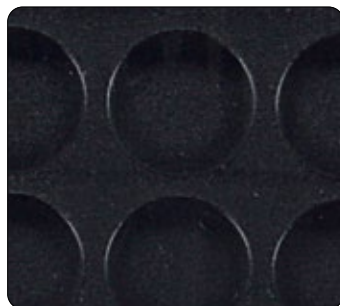

N004
Black

ALUMINIUM

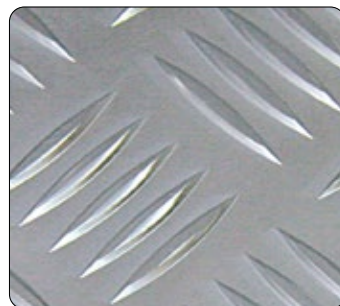

5 bar aluminium tread plate

Finishes - RAL paints

BEIGE COLOURS

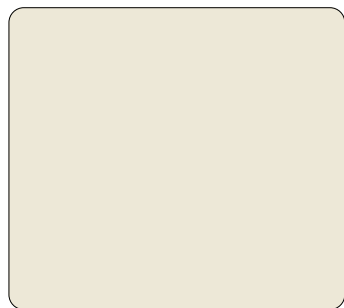

RAL 9001
Cream

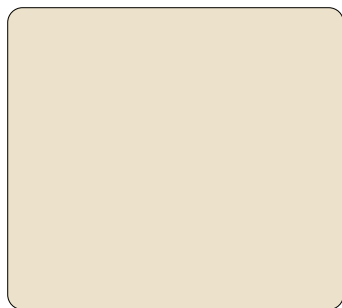

RAL 1013
Oyster white

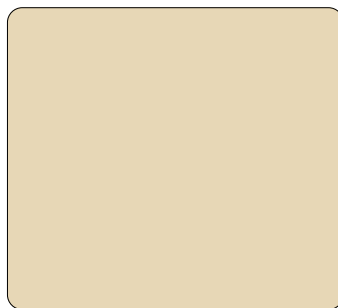

RAL 1015
Light ivory

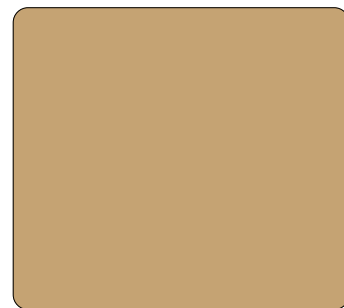

RAL 1001
Beige

GRAY COLOURS

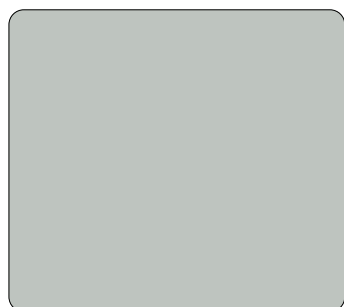

RAL 7035
Light grey

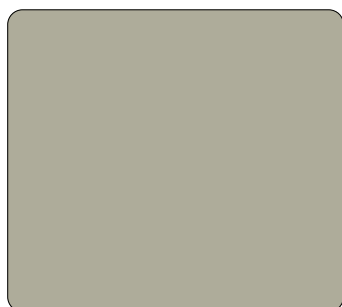

RAL 7032
Pebble grey

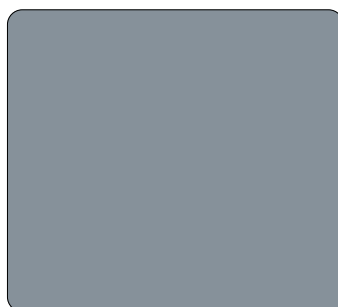

RAL 7001
Silver grey

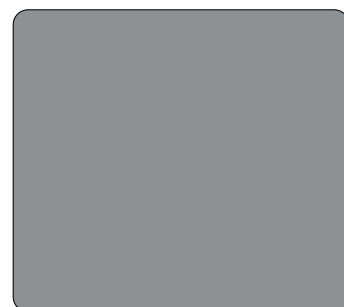

RAL 7004
Signal grey

NEUTRAL COLOURS



RAL 9010
Pure white



RAL 9016
Traffic white

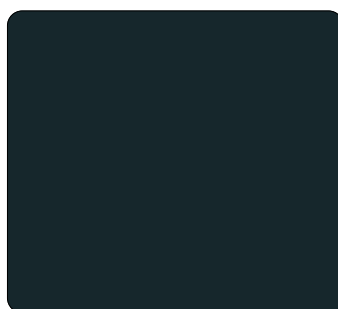

RAL 7016
Anthracite grey

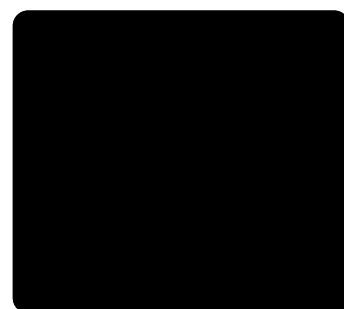

RAL 9005
Jet black

ALUMINUM

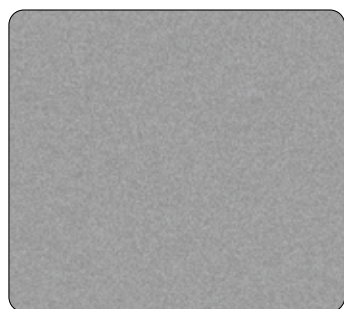

RAL 9006
White aluminium



RAL 9007
Grey aluminium

RED COLORS

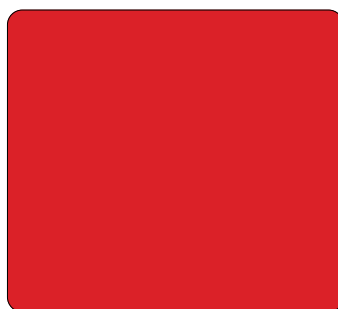

RAL 3020
Traffic red



RAL 3003
Ruby red

Finishes - RAL paints

BROWN COLOURS

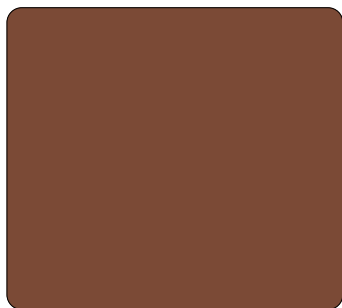

RAL 8003
Clay brown

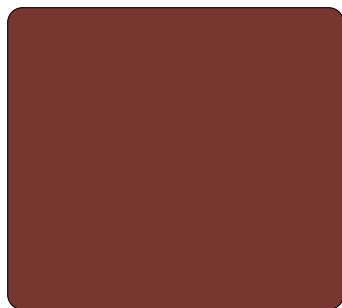

RAL 8002
Signal brown



RAL 8011
Nut brown

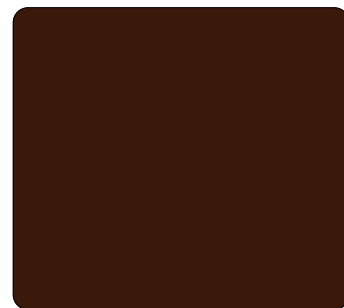

RAL 8017
Chocolate brown

GREEN COLOURS

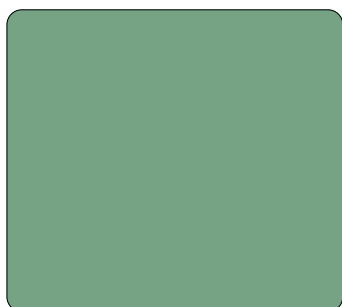

RAL 6021
Pale green



RAL 6001
Emerald green



RAL 6005
Moss green

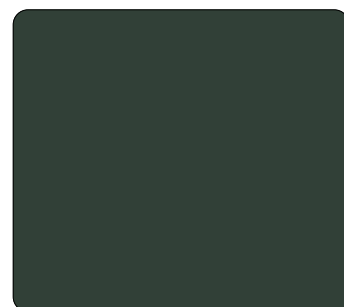

RAL 7009
Green grey

BLUE COLOURS



RAL 5024
Pastel blue



RAL 5015
Sky blue



RAL 5010
Gentian blue

SPECIAL PAINTS

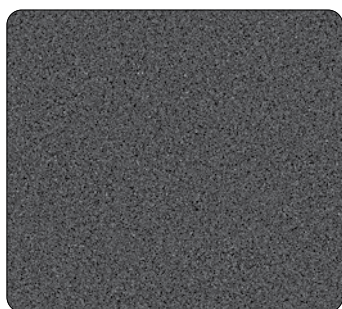

GREY MICA
Grey mica

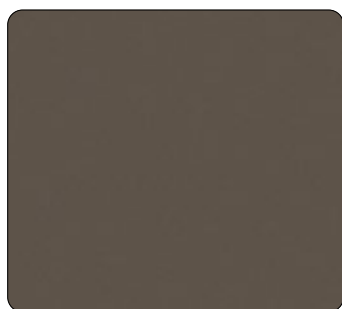

BRONZE 2525 - YW283 F
Bronze

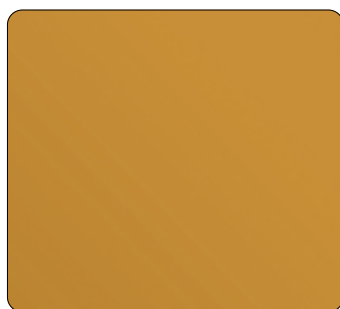

GOLD 2525 - YW106 I
Gold

Overall installation configurations

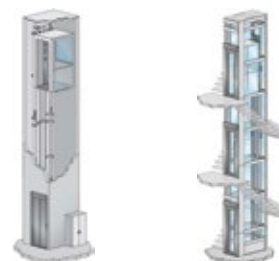

PRODUCT SPECIFICATIONS	InDomo	StairFit
MAX PAYLOAD	500 kg	250 kg
MAX TRAVEL	20 m	20 m
MAX ENTRANCES	3	1
MAX STOPS (in line)	8	8
SHAFT		
CONCRETE OR MASONRY	■	—
STEEL STRUCTURE, PAINTED RAL	□	■
STAINLESS STEEL STRUCTURE (AISI 304 or AISI 316 FOR MARINE ENVIRONMENT)	□	—
CARS		
SMART	■	—
STYLE	□	—
IDEA	□	■
OPERA	□	—
1 GLASS WALL	□	—
2 GLASS WALLS	□	■
CAR DOORS		
WITHOUT DOOR (with LIGHT CURTAIN)	■	■
AUTOMATIC SLIDING, 2-PANELS SIDE OPENING (BL-GL)	□	—
AUTOMATIC SLIDING, 2-PANELS CENTRE OPENING (BL-GL)	□	—
AUTOMATIC SLIDING, 3-PANELS SIDE OPENING (BL-GL)	□	—
AUTOMATIC TWIST FOLDING 2-PANELS (BL-GL)	—	□
AUTOMATIC TWIST FOLDING 4-PANELS (BL-GL)	□	□
LANDING DOORS		
LUMIERE GL - ALUMINIUM (GLAZED version)	■	■
LUMIERE FBL - ALUMINIUM (BLIND version)	□	—
IRON - STEEL (BL ¹)	■	■
myDOMO pack (coupled with TWIST) (GL-BL)	□	—
AUTOMATIC SLIDING, 2-PANELS SIDE OPENING (BL-BL ¹ -GL)	□	—
AUTOMATIC SLIDING, 2-PANELS CENTRE OPENING (BL-BL ¹ -GL)	□	—
AUTOMATIC SLIDING, 3-PANELS SIDE OPENING (BL-BL ¹ -GL)	□	—
HYDRAULIC TRACTION		
Indirect acting 2:1	■	■
Side direct acting 1:1	☒	—

(1) available also E120 and FIRE RATED EI120 executions

LEGEND	■	☒	□	—
	Standard	Option, no extra price	Optional	Not available
BL-FBL: BLIND version GL: GLAZED version				

AVAILABLE ALSO WITH
AISI 316 STRUCTURE FOR
MARINE ENVIRONMENT

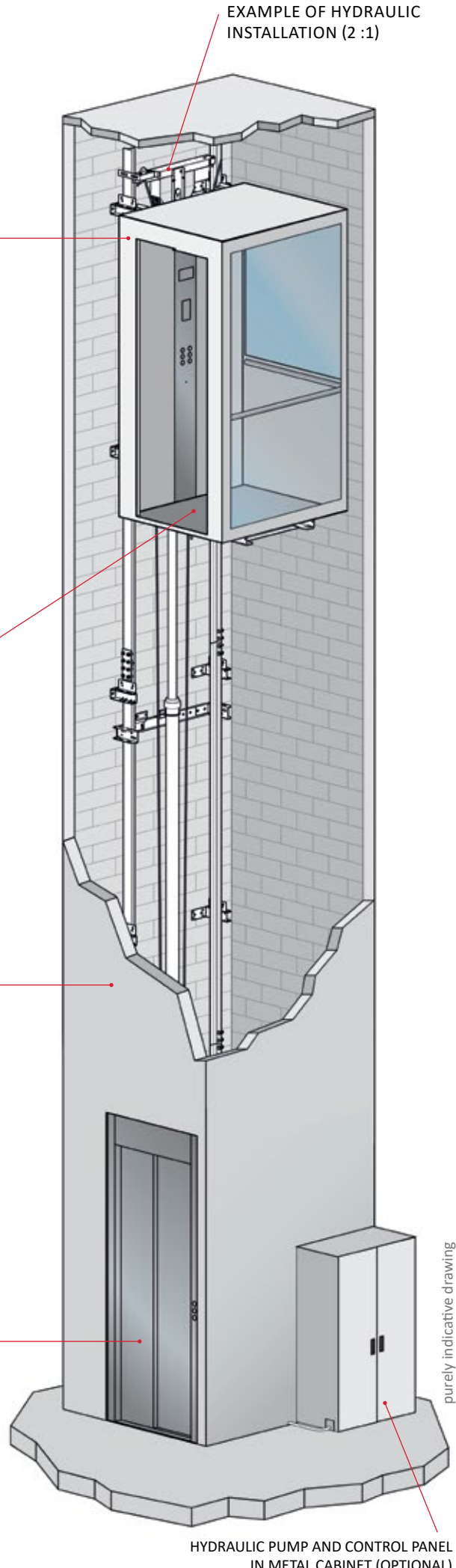
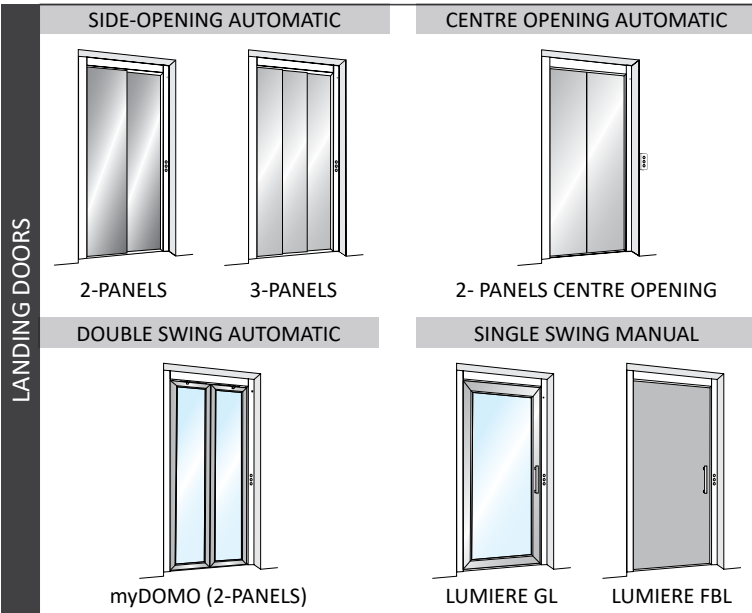
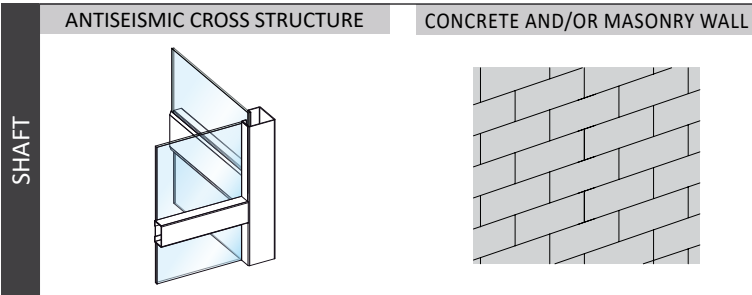
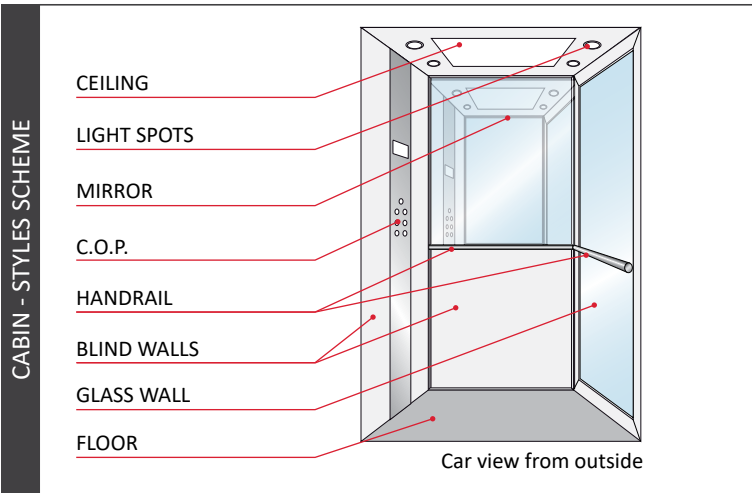
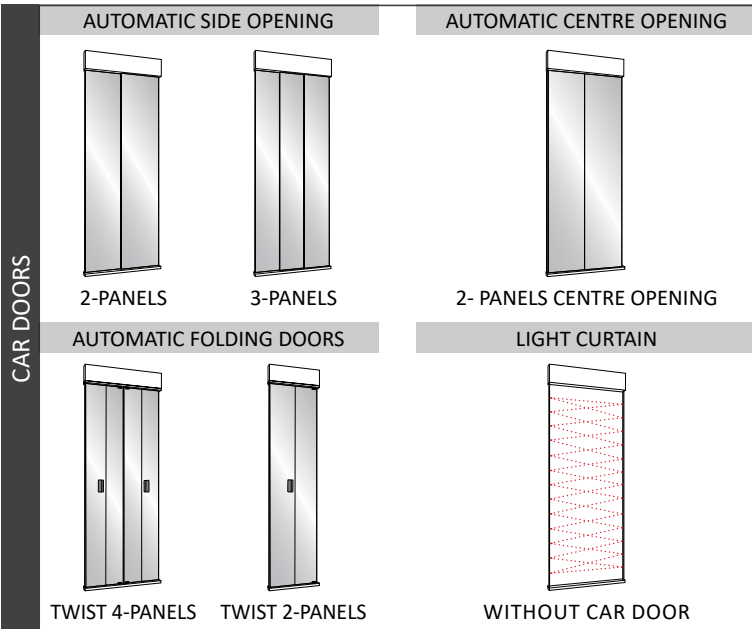

InDomo



Outdoor



Indoor



Suggested
use



Suggested
use



Max payload



230 VAC
single phase

STRENGTH AND RELIABILITY

InDomo means reliability and safety. Thanks to the hydraulic traction, to the solid structure and to the safety devices (blackout emergency descent, automatic rescue call and much more) you will never have to fear of being stuck in the cabin.

TOP COMFORT AT THE BEST PRICE

InDomo is the mini-lift for those who don't accept compromises. Top comfort and quietness, smooth starts and stops, great lighting and best technologies create the best travel experience in the category.

LIVING SPACE

The new range shows a completely renewed line of cabins, with a clean and essential design which will give your house an unmistakable touch of elegance.

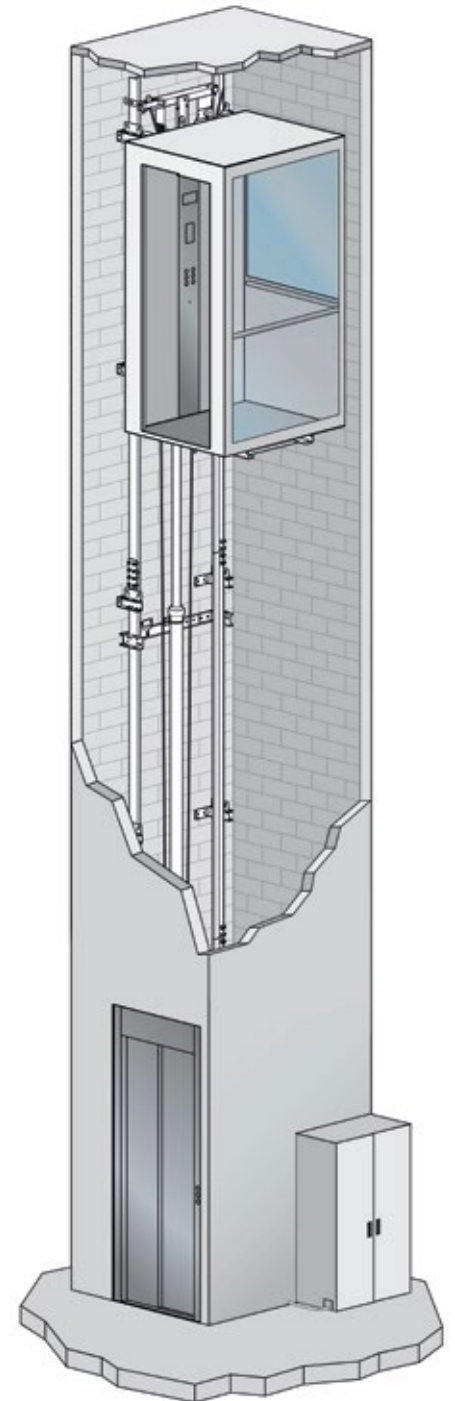

PAYLOADS	From 250 up to 500 kg
TRAVEL	Up to 20 m
STOPS	Up to 8 (in line)
ENTRANCES	Up to 3
SPEED	0,15 m/s (EU) - 0,30 m/s (extra-EU)
SHAFT	Masonry shaft or Anti-seismic structure
CONTROL	Hold to run or Automatic
NOISE LEVEL	Max. 47 dB
CABIN DIMENSION	Max. 1400 (L) x 2000 (P) *
CABIN HEIGHT (CH)	Std. 2100 mm (Min. 2000 - Max. 2200)
DOOR HEIGHT	Std. 2000 mm (Min. 1800 - Max. 2100)
HEADROOM	Std. 2400 mm
PIT	Min. 100 mm - Max. 500 mm
CYCLES/HOUR SUGGESTED	15
POWER SUPPLY	Single phase 230 Vac (3-phase 400 Vac as option)
CONTROL PANEL AND HYDRAULIC SYSTEM	In metal cabinet (optional)
REFERENCE REGULATION	D.M. 2006/42/CE - EN81.41

AVAILABLE WITH ST STEEL AISI316 ANTI-SEISMIC
STRUCTURE FOR MARINE ENVIRONMENT

CUSTOM DIMENSIONS
WITH 5 MM STEPS

MIN DIMENSIONS

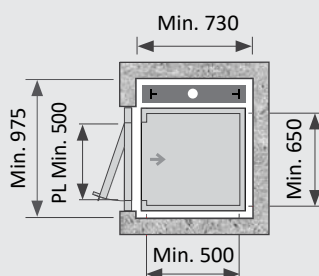

MAX DIMENSIONS

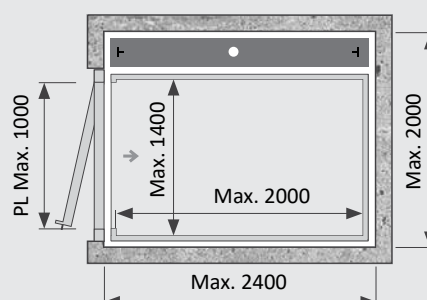

MYDOMO PACK

AUTOMATIC CAR AND
LANDING DOORS KIT

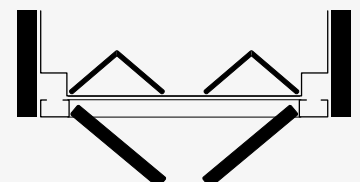

* Reference values cannot be simultaneous

StairFit



Indoor



Suggested use



Suggested use



Max payload



230 VAC single phase

COMFORT IN REDUCED SPACES

We created StairFit for very narrow staircases but keeping a great cabin habitability and comfort thanks to the new “extra breathing system” which includes: full height mirror (C side), panoramic side walls, fan and scotch-brite stainless steel finishing.

CUSTOM DIMENSION TO THE MILLIMETRES

We produce every installation singularly, so that we can take advantage of every inch of available space. STAIRlift was designed to offer the best possible comfort in case of a refurbishment or building upgrades where available spaces are particularly small.

SAFETY AND RELIABILITY

Even in reduced spaces STAIRlift offers the same level of performance and safety features of a standard mini-lift, so that you can always be relaxed.

PAYLOADS	250 kg
TRAVEL	Up to 20 m
STOPS	Up to 8 (in line)
ENTRANCES	1
SPEED	0,15 m/s (EU) - 0,30 m/s (extra-EU)
SHAFT	Anti-seismic structure
CONTROL	Hold to run or Automatic
NOISE LEVEL	Max. 47 dB
CABIN DIMENSION	Width from 500 ÷ 800 * Depth from 650 ÷ 1200 *
CABIN HEIGHT (CH)	Std. 2100 mm (min. 2000 – Max. 2200)
DOOR HEIGHT	Std. 2000 mm (min. 1800 – Max. 2100)
HEADROOM	Std. 2400 mm
PIT	Min. 200 mm - Max. 500 mm
CYCLES/HOUR SUGGESTED	15
POWER SUPPLY	Single phase 230 Vac (3-phase 400 Vac as option)
CONTROL PANEL AND HYDRAULIC SYSTEM	In metal cabinet (optional)
REFERENCE REGULATION	D.M. 2006/42/CE - EN81.41

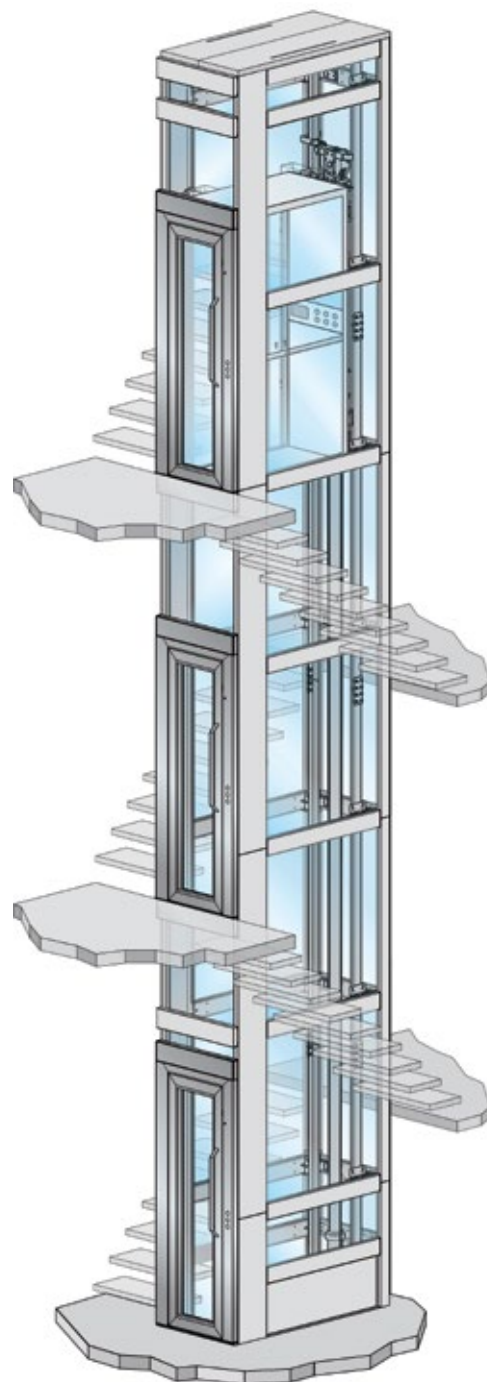

CUSTOM DIMENSIONS WITH 5 MM STEPS

INSTALLATION DIMENSIONS

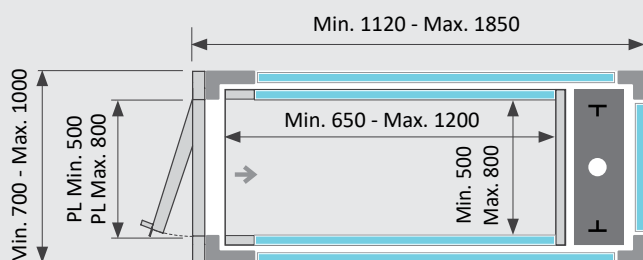

2-PANELS FOLDING DOORS AND AUTOMATIC CONTROL

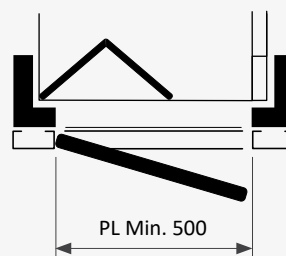

* Reference values cannot be simultaneous

Who we are

LiftingItalia is a young company established by professionals with long experience in the vertical transport sector.

LiftingItalia is specialized in the design and production of home and platform lifts to overcome differences in height up to 20 meters.

Our products are sold in over 30 countries worldwide!

Made in Italy

What makes us unique is the Italian style and the attention to quality which comes from our history as a manufacturing company.

Functional and comfortable, LiftingItalia's homelifts allow you to move easily, in perfect autonomy and with the charm that distinguishes the Italian style.

LiftingItalia and AreaLift

The group consists of two young and dynamic companies that work in perfect synergy completing each other.

LiftingItalia - Established in 2003, is the parent company and today is specialized in the production of **high quality homelifts**.

AreaLift - Established in 2006, is a company **specialized in accessibility solutions and vertical mobility**.



LIFTING ITALIA S.r.l.

Via Caduti del Lavoro, 16
43058 Bogolese di Sorbolo - Parma, Italy
Tel. +39 0521 695311

www.liftingitalia.com



Authorized reseller